

CIVINTEC[®]

**Product Line
Brochure**

Contents

Access Control Terminals

- 4G, WiFi & TCP/IP Access Control Terminal - CT9 FAMILY
- Intelligent Access Control Terminal – uTouch



Access Control Readers

- Cidron Family Reader
- Crystal Touch Reader
- Crystal Keypad Reader
- CN56X0B family Reader



CRYSTAL TOUCH

CT9 FAMILY

Smart Wireless & Ethernet PoE
Cloud HTTP IoT & Access Control
Terminal with Multi-technologies
RFID, BLE and QR Code reader



CT9 FAMILY GUIDANCE



CT9 E Series

Touch Keypad Terminal

CT9 PRO Series

3.5" Touch Screen Terminal

CT9 PRO-D Series

3.5" Touch Screen Terminal
with HID reader

HTTP SERVER CENTRALIZED ACCESS CONTROL & IOT SYSTEM WITH RFID/QR CODE/MOBILE ID READER

3.5" Touch Screen or Touch Keypad Terminal
with Embedded **LINUX OS & SDK**

+

Embedded **4G, WiFi & TCP/IP** Ethernet **HTTP/HTTPs**
for both LAN & Internet Server Software

+

Embedded **Relays** Control for Lock & Facility Control
Support both of **HOST Mode & Local Mode**

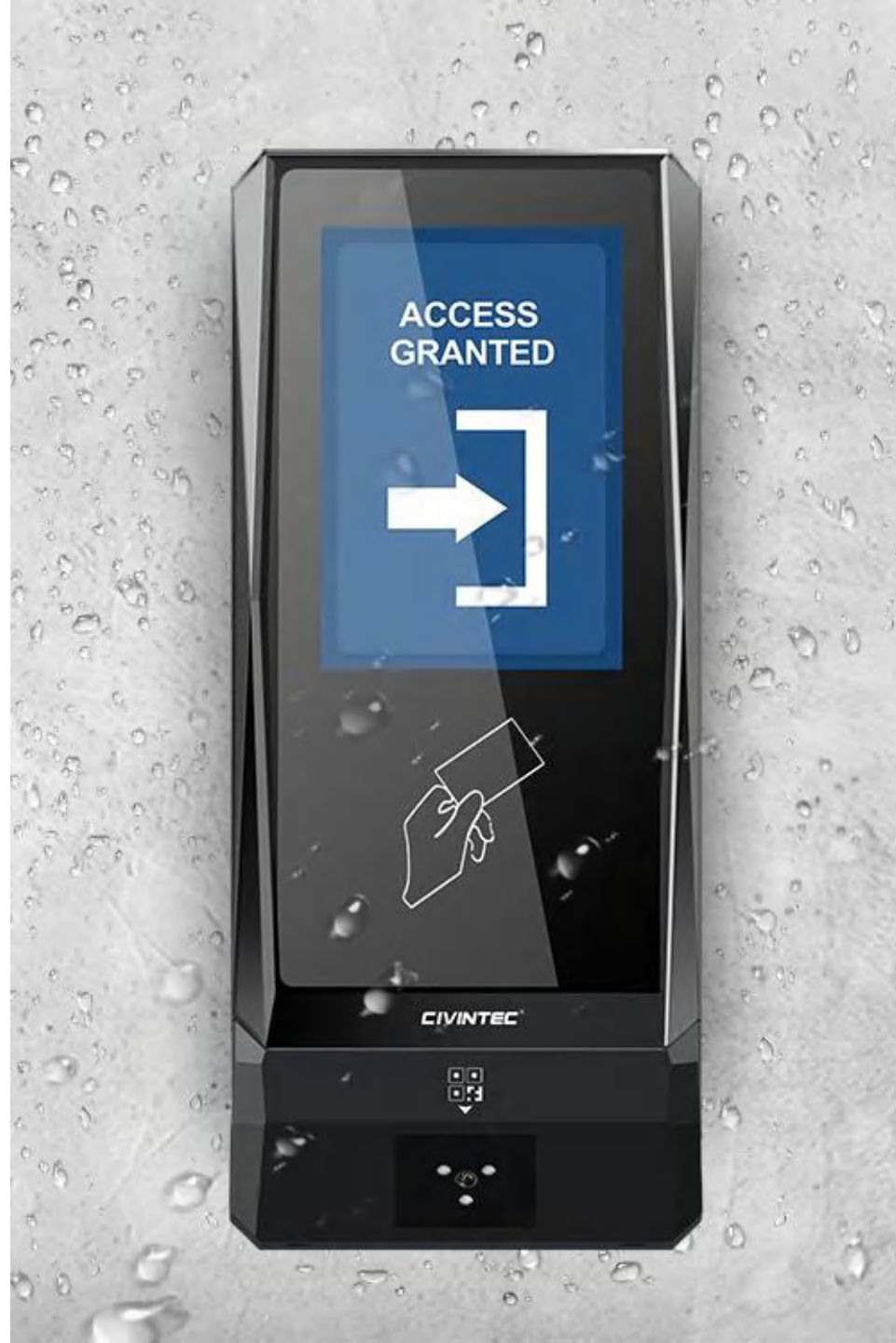

5-in-1 MULTIPLE IDENTIFICATION



1

MOBILE CREDENTIAL

Use personal smart phone via ISO18092 NFC & BLE (Bluetooth Low Energy)



2

SMART WATCH

Support smart watch virtual credential



3

QR CODE

QR code scanner to support multi-formats QR Code 1D & 2D codes, QR & Micro QR codes and Barcode

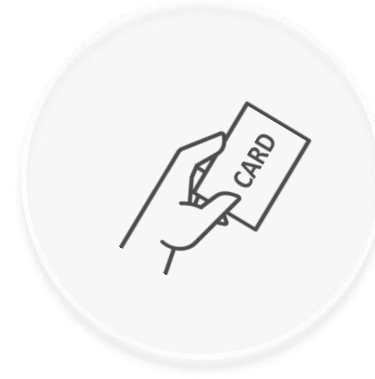

4

RFID SMART CARD

Support 125KHz & 13.56MHz Mifare, DESFire EV1/EV2/EV3, Mifare Plus and ISO14443B card, HID iCLASS, Seos smart cards

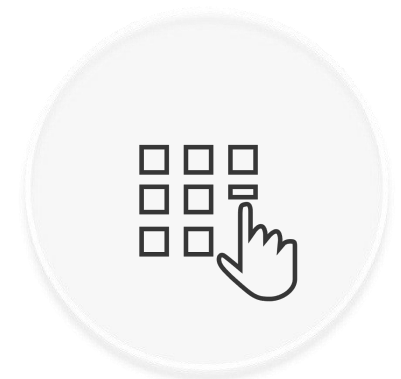

5

PIN CODE

3*4 Touch Pincode with backlight LEDs to give extra protection for access control

EASY CONFIGURABLE USER INTERFACE

Stylish Linux 3.5" colorful touch screen bring intuitive and clear feedback to visitor. Give access for user to easily program UI and display customized pictures and TEXT, branding LOGO by software tool and HTTP commands

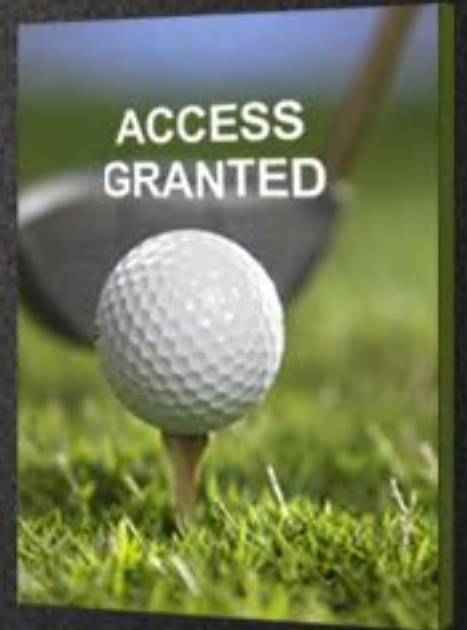
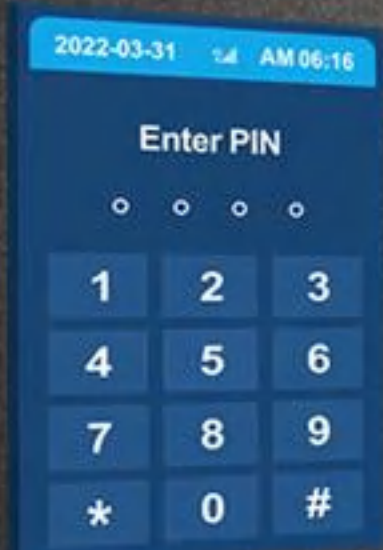

CLOUD SERVER REMOTE CONTROL FOR SECURITY & IOT SYSTEM

Bio-direction communication to GET/POST commands via standard HTTP/HTTPS between CT9 Family and server to remotely control door lock and various IoT facility management



ONLINE & OFFLINE MODE

- **Online**

CT9 Family sends POST request to web server, server responses to CT9 Family to control access Granted/Denied and display customized picture with TEXT on screen through standard HTTP commands

- **Offline**

Offline database for **10,000** cardholders and **50,000** event logs. Easy to add, delete and edit user ID and access credential on 3.5" touch screen with administrator login password control.

IMPROVED SECURE ACCESS CONTROL SYSTEM

CT9 Family give protection on door access by APB access control reader, with relay control to unlock door, features Power Over Ethernet (PoE) for less wiring and cost-save installation

RELAY CONTROL

CT9 Family is with controllable relay output by software command to unlock electronic door lock and facilities.



POE

Support Power Over Ethernet IEEE 802.3af for cost save and easy installation.



APB READER

CT9 Family is with RS485/wiegand to work with Cidron family slave readers for best performance and to achieve a encrypted secured level of smart card technologies.



EXIT BUTTON

CT9 Family with various inputs to control exit button and door contact with configurable settings.



CRYSTAL TOUCH PRO	CT9 E	CT9 PRO	CT9 PRO-D
RFID Contactless Cards	<ul style="list-style-type: none"> - 125KHz PROx, 125KHz EM - 13.56MHz Mifare® Classic, Ultralight®, Mifare® Plus, DESFire® EV1/ EV2/ EV3, NFC tags 	<ul style="list-style-type: none"> - 125KHz PROx, 125KHz EM - 13.56MHz Mifare® Classic, Ultralight®, Mifare® Plus, DESFire® EV1/EV2/EV3, NFC tags 	<ul style="list-style-type: none"> - 13.56MHz Mifare® Classic, Ultralight®, Mifare® Plus, NFC tags, DESFire® EV1/EV2/EV3; HID iCLASS; HID Seos - 125KHz HID Prox, Indala, EM4100/4102 and HITAG
Mobile Credential	BLE (2.4Ghz), NFC		BLE (2.4Ghz), NFC and HID mobile virtual card
Barcode / QR scanner	Support		
Keypad	Touch screen keypad 12 keypad in 4 rows of 3 keys		
Communication Interfaces	<ul style="list-style-type: none"> - TCP/ IP(RJ45) - 4G - WiFi 2.4GHz IEEE802.11b/g/n - RS485, wiegand input 	<ul style="list-style-type: none"> - TCP/ IP(RJ45) - 4G - RS485, wiegand input 	<ul style="list-style-type: none"> - TCP/ IP(RJ45) - 4G - WiFi 2.4GHz IEEE802.11b/g/n - RS485, wiegand input
I/O port	- 3* Inputs - Door contact, Door exit, Buzzer control - 4* Outputs - Tamper alarm switch, Output Buzzer control, Access Granted, Access Denied		
Relay	1 or 2 relay outputs		
Fire alarm	2 * Inputs to connect fire alarm	On request	
Display	--	3.5" touch screen	
Offline Card Users / Event logs	10,000 users / 50,000 logs		
Indicators	<ul style="list-style-type: none"> - Controllable tri-color LEDs - Controllable Buzzer and speaker 	<ul style="list-style-type: none"> - TP display - Controllable buzzer and speaker 	
Housing Dimensions	- Basic Model: 24mm(D) * 165mm(H) *84mm(W) - QR/4G/ PoE Model: 45mm(D) * 200mm(H) *84mm(W)		
Power supply	- 12~ 24V DC - PoE IEEE 802.3af		12-24V DC
Protection Class	- IP65 electric epoxy potted (request waterproof spacer) - Resistant to UV ray (suitable for UV-resistance model)		
Operation Temperature	-30°C ~ 60°C	-20°C ~ 60°C	

VERSATILE IOT APPLICATIONS

Wireless Server Remote Control CT9 Family with SDK is flexible to build various kinds of security & IoT applications



Access Control

- Physical Access Control
- Visitor Access Management
- Function Room Reservation
- Turnstile & Lock Control
- Condominiums Door Control



Time Attendance

- HR Time Attendance
- Labor Attendance Management
- Mobile Staff Working Track
- Cloud real-time Attendance



Loyalty & Luxury Payment

- Membership Management
- Booking System
- Gym & Course Management
- Golf courses & Tennis Court



IoT & Facility Control

- Court barrier & Light Control
- Water Meter Remote Control
- Factory Equipment Control

UTOUCH NEW GENERATION CN890

7" Touch Screen Intelligent Biometric Access Control Terminal





ANDROID / LINUX

QUAD-CORE PROCESSOR

Customizable on friendly user interface
and easier to integrate new
APPs with SDK API

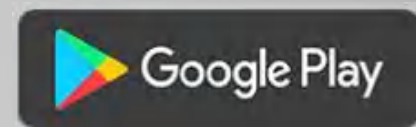

ACCESS CONTROL & TIME ATTENDANCE



25,000

Biometric
Fingerprint Templates



100,000

Card Holders



1,000,000

Event Logs

VERSATILE COMMUNICATIONS

Easily get networked through IP Ethernet, BT, WiFi and 4G for bi-direction data communication and synchronize in real time, and remotely manage networked uTouch X from different locations.



TCP/IP



PRODUCT FEATURES



7.0 inch capactive touch screen

sensitive and high resolution screen
comfortable for user experience



NFC&RFID contactless smart card options

ISO18092NFC,13.56MHz,MIFARE®,
MIFARE Plus,DESFire®EV1; 125KHz
SAM slot for securedata encryption



Reliable biometric fingerprint security

Support both 1:N and 1:1 fingerprint
enrollment (store fingerprint into smart
card) with added privacy



Embedded auto focus camera

5.0M pixel digital camera with auto focus,
microphone and speaker

POE

Power over ethernet

PoE for stable and low cost installation



Versatile communication interfaces

WiFi, 4G,BT4.0, TCP/IP, USB

GENERAL APPLICATIONS

GENERAL PURPOSE
INTELLIGENT TERMINAL
PROVIDE POWERFUL AND
COMPREHENSIVE SOLUTIONS



CIDRON FAMILY READER

4-in-1 OSDP Access Control Reader

 CIDRON





FIRST CLASS QUALITY

Original

100% SWEDISH DESIGN

Innovative

WORKED WITH **OVER 40** CONTROLLER BRANDS

GLOBAL MARKET

Sell to

128 countries

Used In

GOVERNMENT, AIRPORT, CAMPUS,
HOTEL AND UTILITY BUILDINGS

4-in-1 MULTIPLE IDENTIFICATION



1

MOBILE CREDENTIAL

Use personal smart phone via ISO18092 NFC & BLE (Bluetooth Low Energy)

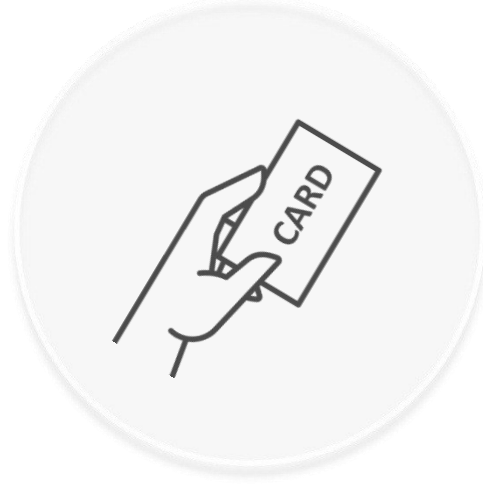

2

RFID SMART CARD

Read/write 125KHz & 13.56MHz Mifare, DESFire EV1/EV2, Mifare Plus and ISO14443B card



3

QR CODE

Multi format QR codes 1D & 2D codes. QR & Micro QR codes, Barcode and QR codes used in paper or mobile phone.



4

PIN CODE

Customizable 3*4 Touch Pincodes to give extra protection for access control



MULTIPLE COMMUNICATION INTERFACES

Universal compatibility to all access controller brands.

- Addressable RS485, OSDP 1& 2 protocol (including Secure channel)
- Wiegand 1024 with customized wiegand format
- Clock&Data

ULTRA ROBUST DESIGN

CIDRON family reader with robust design makes them ideally suited in all kinds of physical access control occasions. Cidron is with Thermostat controlled embedded heater ideal for ultra low temperature - $40^{\circ}\text{C} \sim +70^{\circ}\text{C}$.





VISUAL INDICATOR DESIGN

The substantial LED frame provides visual indications with green, red or yellow. The LED frame, backlight and buzzer can all be configured to indicate different operations and events using sound or light to communicate with the user. The indications can also be activated by external controls by using general purpose input/output's (GPIO's).



ACCESSORIES FOR THE CIDRON READER

Cidron family reader is designed with various accessories to facilitate installation in all kinds of occasions. The Cidron reader vandalization protection protects the reader and helps it withstand violence by absorbing and redirecting external forces away from the reader. Distance plate with different angled enables smooth and flexible installations, and increase accessibility as well as visibility of the Cidron reader keypad. The tamper switch tray can help Cidron reader suitable for uneven wall installation and all kinds of mounting surface installation.

>Cidron Family Comparison

Specs	VG2	VG3	VG3+QR	CIDRON E
Reader Housing				
Dimension	Standard: L=109mm, H=25mm, W=79mm Slimline: L=141mm, H=25mm, W=48mm	Standard: L=109mm, H=25mm, W=79mm Slimline: L=141mm, H=25mm, W=48mm	Standard: L=143mm, H=80mm, W=91mm Slimline: L=180mm, H=95mm, W=63mm	L=141mm, H=25mm, W=48mm
RFID smart card	- 125KHz - 13,56MHz ISO14443A/B, ISO18092 NFC	- 125KHz - 13,56MHz ISO14443A/B, ISO18092 NFC	- 125KHz - 13,56MHz ISO14443A/B, ISO18092 NFC	13,56MHz ISO14443A
Contactless Card Supported	- EM4100/4102/4200/Prox, - Mifare® Classic, Mifare® Plus, Desfire® EV1 - ISO14443B UID - NFC Tags	- EM4100/4102/4200/Prox, - Mifare® Classic, Mifare® Plus, Desfire® EV1/EV2 - ISO14443B UID - NFC Tags	- EM4100/4102/4200/Prox, - Mifare® Classic, Mifare® Plus, Desfire® EV1/EV2 - ISO14443B UID - NFC Tags	Mifare® Classic, Desfire® EV1/EV2
NFC Mobile ID	Yes	Yes	Yes	No

Specs	VG2	VG3	VG3+QR	CIDRON E
BLE (bluetooth low engery)	No	Yes	Yes	No
QR Code	No	No	Yes	No
Secure Access Module	ISO7816 SAM MIFARE SAM AV2	ISO7816 SAM MIFARE SAM AV2	ISO7816 SAM MIFARE SAM AV2	No
communication interface	Wiegand, RS485 (OSDP 1, OSDP 2, including Secure channel), Clock/Data	Wiegand, RS485 (OSDP 1, OSDP 2, including Secure channel), Clock/Data	Wiegand, RS485 (OSDP 1, OSDP 2, including Secure channel), Clock/Data	Wiegand, RS232, RS485 (OSDP 1, OSDP 2, including Secure channel)
Power Supply	+9-30VDC	+9-30VDC	+9-30VDC	+9-12VDC
Temperature	-40 ~ +70°Cwith heater	-40 ~ +70°Cwith heater	-40 ~ +70°Cwith heater	-20 - + 60°Cwithout heater
Ingress Protection Classification	IP65 (request weather protection casing)	IP65 (request weather protection casing)	IP65 (request weather protection casing)	IP65 (request weather protection casing)
Compliances	CE, RoHS, UK CA	CE, RoHS, FCC, UK CA	CE, RoHS, FCC, UK CA	CE, RoHS, UK CA
Configuration Card	yes	yes	yes	yes
Firmware upgrade	yes	yes	yes	yes

CRYSTAL FAMILY READER

CT5-CK5

Stylish OSDP RFID & Mobile ID
Access Control Reader



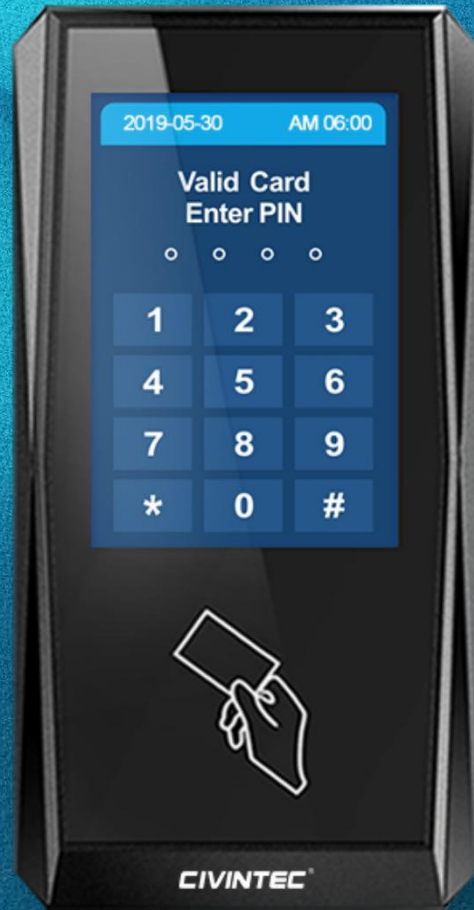

TOUCH FREE MOBILE ID ACCESS CONTROL READER

Support BLE and ISO18092 NFC by
using personal smart phone for
access control



3.5" TOUCH SCREEN

Waterproof Outdoor Use



TOUCH PINCODE

Customizable Touch Pincode



2.4" OLED DISPLAY

PROGRAMMABLE TEXT

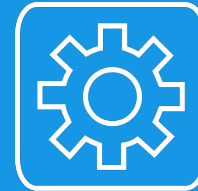

MECHANICAL KEYPAD

12 digit keypad with white LED backlit

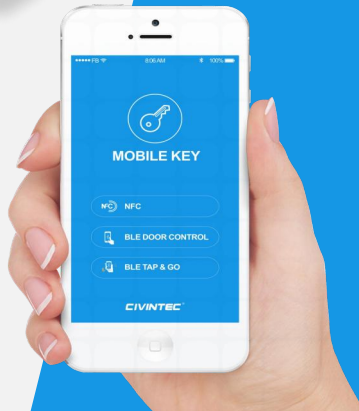

3-in-1 MULTIPLE IDENTIFICATION



1

MOBILE CREDENTIAL

Use personal smart phone via ISO18092 NFC & BLE (Bluetooth Low Energy)



2

RFID SMART CARD

Read/write 125KHz & 13.56MHz Mifare, DESFire EV1/EV2, Mifare Plus and ISO14443B card



3

PIN CODE

Customizable 3*4 Touch Pincodes to give extra protection for access control



PROGRAMMABLE TEXT & IMAGE ON SCREEN

The stylish Linux 3.5" colorful touch screen and 2.4" OLED display access control reader freely display customized picture with TEXT on screen controlled by Controller Panel



MULTIPLE COMMUNICATION INTERFACES

Universal compatibility to all access controller brands.



- Addressable RS485, OSDP 1& 2 protocol (including Secure channel)
- Wiegand 1024 with customized wiegand format
- Clock&Data

Crystal Touch	CT5 Specification
Display	3.5" touch screen
Operation System	LINUX
Keypad	Touch PIN pad
ISO-protocol	125KHz Prox, 125KHz EM, 13.56MHz Mifare®Classic, Ultralight®,Ultralight®C, Mifare®Plus, DESFire® EV1/EV2,NFC tags (T2T, T4T)
Secure Access Module	ISO7816 (T=0, T=1) 1 SAM module, more on request
Communication Interface	1x Wiegand Out (26-1024bit) ,RS485(OSDP protocol), BLE 4.0
Power Supply	9-30V DC
Indicator	Controllable buzzer and TP display, speaker with controllable volume
I/O Port	2*I/O Port, 1* tamper alarm switch
IP Protection	IP65 outdoor/indoor use
Operation Temperature	-20 ~ +60°C
Certification	CE & RoHs3

CRYSTAL KEYPAD**CK5-MX-X Specification**

ISO-protocol	13. 56MHz ISO14443A/B, ISO15693, ISO18092 NFC, 125KHz
Contactless cards	125KHz P rox, EM4100, EM4200 Mifare@S50/S70, Ultralight@(C), DesFire@ EV1/EV2, Mifare@ Plus S,X NFC forum tag T2T, T4T
Mobile ID	ISO18092 NFC, BLE 5.0
Secure Access Module	ISO7816 Standard Mini Card Slot, MIFARE SAM AV2
Display	2.4" OLED, 128x64 white characters on black background
Keypad	12 digit keypad in 4 rows of 3 keys in each row with white LED backlit,intensely adjustable; Keypad output format Weigand 4bit, Weigand 8bit (Dorado), Weigand 26bit & OSDP ASCII format
Communication Interface	RS485, OSDP, Weigand 24-1024
Indicator	intensely adjustable; Keypad output format Weigand 4bit, Weigand Green, yellow (bio-color) or Mixed color Status Indicators, Buzzer
GPIO	2 configurable GPIO
Tamper Alarm	Built-in mechanical tamper switch which allows for indication both break off protection and opening of the reader
Power supply	9-30V DC
Ingress Protection Classification	IP65
Housing dimensions	165mm (H) * 84mm (W) * 20mm (T)
Operating temperature	-40°C ~ +60°C, With thermostat controlled embedded heater
Certification	CE, RoHS

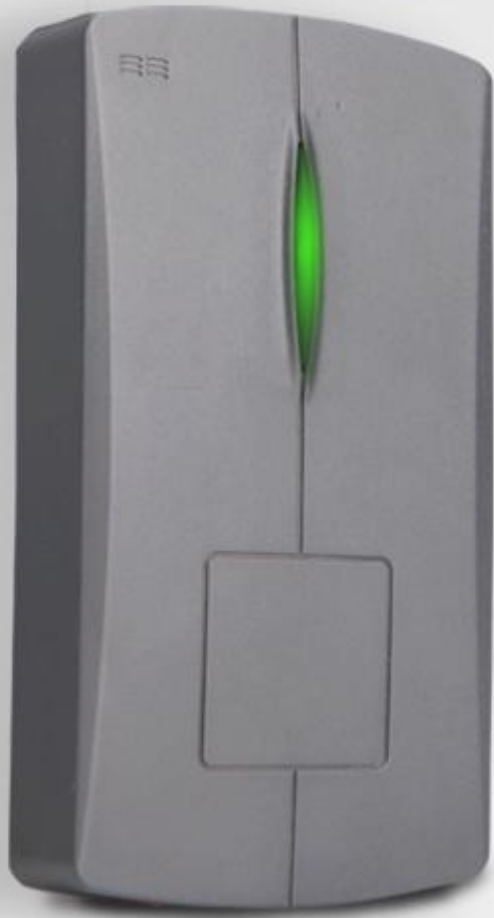

CN-FAMILY READER

CN56X0B

Economic RFID NFC Access
Control Reader

RFID IDENTIFICATION



1

MOBILE ID TOUCHLESS ACCESS

Support ISO18092 NFC smart phone and Ntags



2

RFID SMART CARD

Read/write 13.56MHz Mifare, DESFire EV1, Mifare Plus and FeLiCa cards

HIGH COMPATIBILITY WITH CONTROLLER AS SLAVE READER

wide operating voltage, CN56X0B is with high compatibility for most controllers on the market.

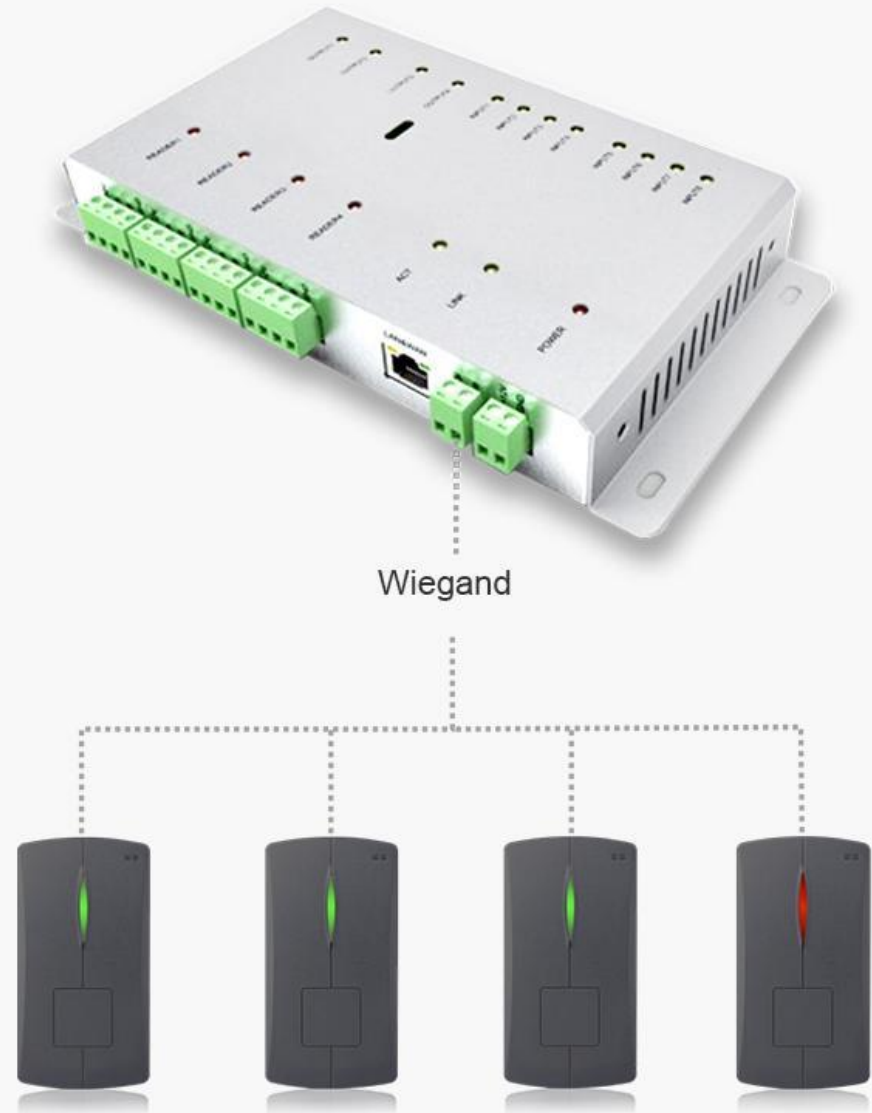

PC SERVER MANAGEMENT

Embedded TCP/IP with HTTP protocol supported and relay control for centralized server management solution. Control large RFID readers to input and output mass tag data over TCP/IP network effectively.

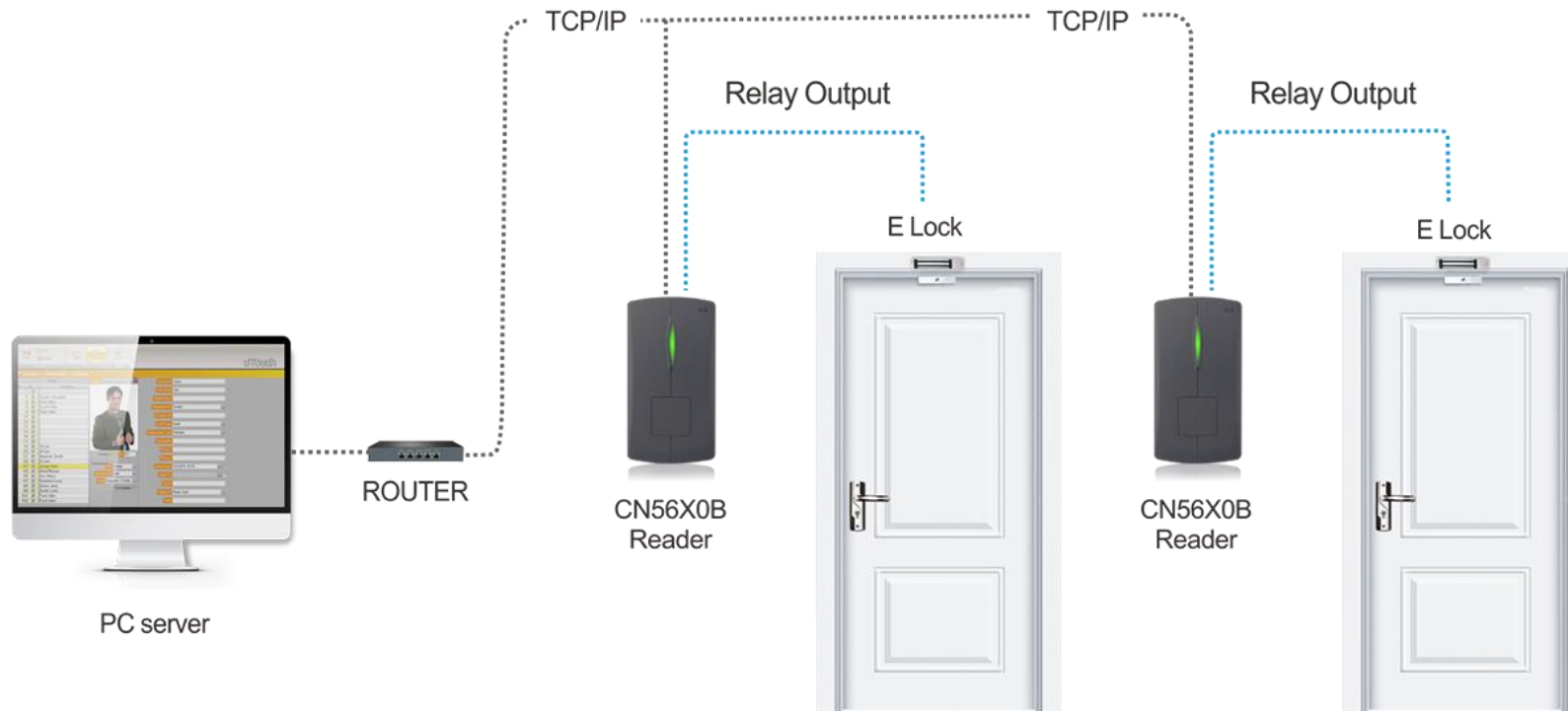

Model**CN56X0B-X-XX Specification**

Operating Frequency

13.56MHz

ISO18092

ISO18092 NFC peer to peer

RFID Standard

ISO14443A4(part 1 -4), Mifare, Mifare Plus and DesFire EV1, Felica

RFID Card Supported

Ultralight, Mifare 1K/4K, Mifare Pro/Prox, Mifare Plus, DESFire EV1 and other ISO14443A NFC tags (T2T, T4T) compatible cards, Sony Felica, ISO14443B on request

Power Supply

9V DC (9-24V), <1 50mA

Interface

RS232\RS485\TCP/IP, Wiegand (26, 34, 42, 50, 58) / Clock & Data 8, 1 0 / ABA1 , 2

Reading output format

Wiegand 26, 34, 42, 50, 58 / Clock & Data 8, 1 0 (3 byte, 5byte, HEX, ASCII) / ABA1 , 2

Indicators

Bio-color LED and Buzzer controlled by three-wires

Operating Temperature

-20°C`+60°C/-4°F`140°F

Protection Class

IP65,electric epoxy potted for harsh environment

THANK YOU

CIVINTEC[®]

CiVinTec Global CO., Limited.

sales@civintec.com
Version 7.0 January 26.2024